

300mW, NPN Small Signal Transistor

FEATURES

- Low power loss, high efficiency
- Ideal for automated placement
- High surge current capability
- Moisture sensitivity level: level 1, per J-STD-020
- Compliant RoHS
- Halogen-free according to IEC 61249-2-21

APPLICATIONS

- Switching mode power supply (SMPS)
- Adapters
- Lighting application
- On-board DC/DC converter

MECHANICAL DATA

- Case: SOT-23
- Molding compound meets UL 94 V-0 flammability rating
- Terminal: Matte tin plated leads, solderable per J-STD-002
- Meet JESD 201 class 1A whisker test
- Weight: 8mg (approximately)

KEY PARAMETERS		
PARAMETER	VALUE	UNIT
V_{CBO}	50	V
V_{CEO}	45	V
V_{EBO}	5	V
I_C	500	mA
h_{FE}	250-600	
Package	SOT-23	
Configuration	Single die	

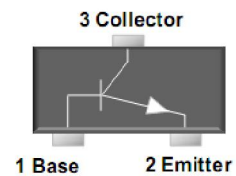

ABSOLUTE MAXIMUM RATINGS ($T_A = 25^\circ\text{C}$ unless otherwise noted)					
PARAMETER	SYMBOL	BC817-16	BC817-25	BC817-40	UNIT
Marking code on the device		6A	6B	6C	
Power dissipation	P_D	300			mW
Collector-base voltage, emitter open	$I_C = 10 \mu\text{A}, I_E = 0$	V_{CBO}	50		V
Collector-emitter voltage, base open	$I_C = 10 \text{mA}, I_B = 0$	V_{CEO}	45		V
Emitter-base voltage, collector open	$I_E = 1 \mu\text{A}, I_C = 0$	V_{EBO}	5		V
Collector current, dc	I_C	500			mA
Junction temperature	T_J	-55 to +150			$^\circ\text{C}$
Storage temperature	T_{STG}	-55 to +150			$^\circ\text{C}$

ELECTRICAL SPECIFICATIONS ($T_A = 25^\circ\text{C}$ unless otherwise noted)						
PARAMETER	CONDITIONS	SYMBOL	MIN	TYP	MAX	UNIT
Collector cutoff current, emitter open	$V_{CB} = 45\text{ V}, I_E = 0$	I_{CBO}	-	-	0.1	μA
Emitter cutoff current, collector open	$V_{EB} = 4\text{ V}, I_C = 0$	I_{EBO}	-	-	0.1	μA
DC current gain	$V_{CE} = 1\text{ V}, I_C = 100\text{ mA}$	BC817-16	100	-	250	
		BC817-25	160	-	400	
		BC817-40	250	-	600	
Collector-emitter saturation voltage	$I_C = 500\text{ mA}, I_B = 50\text{ mA}$	$V_{CE(sat)}$	-	-	0.7	V
Base-emitter saturation voltage	$I_C = 500\text{ mA}, I_B = 50\text{ mA}$	$V_{BE(sat)}$	-	-	1.2	V
Transition frequency	$V_{CE} = 5\text{ V}, I_C = 10\text{ mA}, f = 100\text{ MHz}$	f_T	100	-	-	MHz

ORDERING INFORMATION		
ORDERING CODE (Note1, 2)	PACKAGE	PACKING
BC817-XX RF	SOT-23	3K / 7" Reel
BC817-XX RFG	SOT-23	3K / 7" Reel

Note:

- "xx" is device code "16", "25" and "40"
- "G" means green compound (halogen free)

CHARACTERISTICS CURVES

($T_A = 25^\circ\text{C}$ unless otherwise noted)

Fig.1 Typical Pulsed Current Gain VS. Collector Current

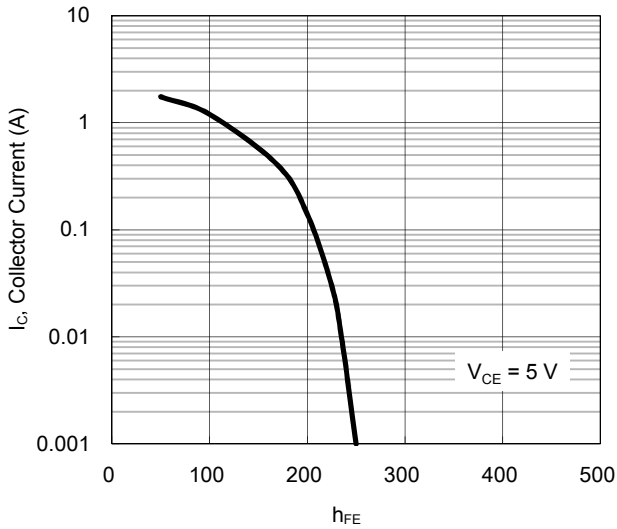

Fig. 2 Collector-Emitter Saturation Voltage VS. Collector Current

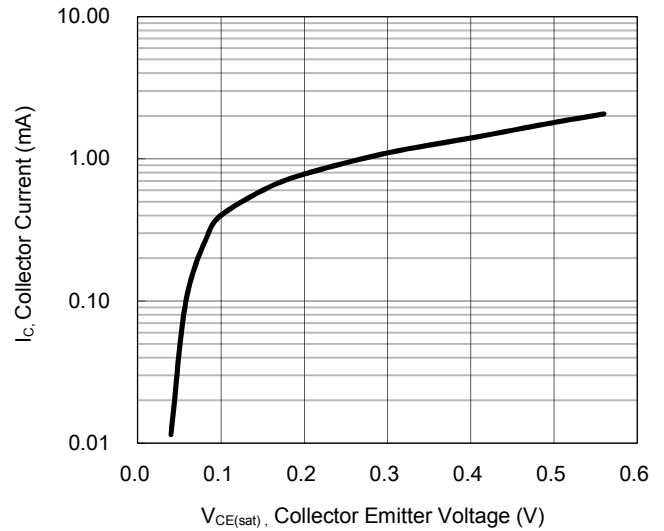

Fig.3 Base-Emitter Saturation Voltage VS. Collector Current

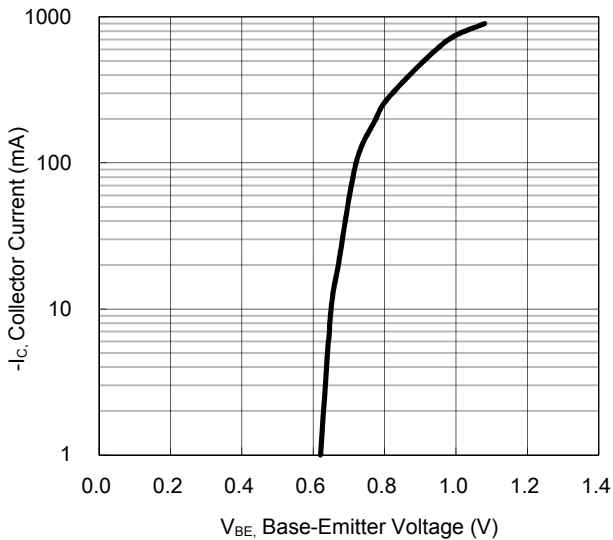
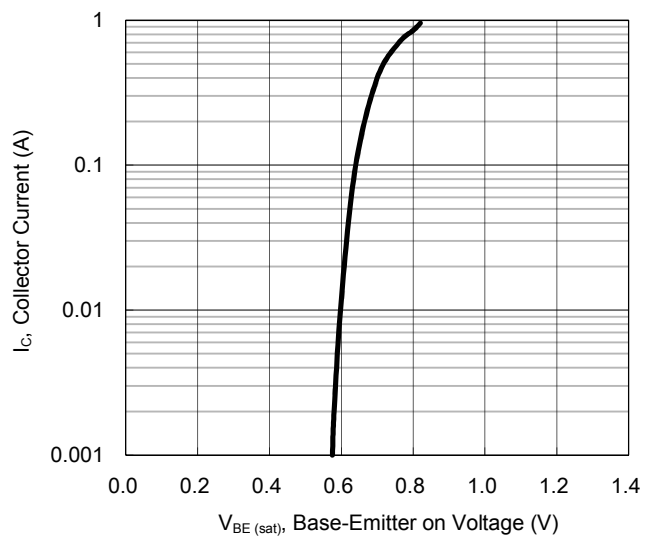

Fig.4 Base-Emitter On Voltage VS. Collector Current



CHARACTERISTICS CURVES

($T_A = 25^\circ\text{C}$ unless otherwise noted)

Fig.5 Collector-Base Capacitance VS. Collector-Base Voltage

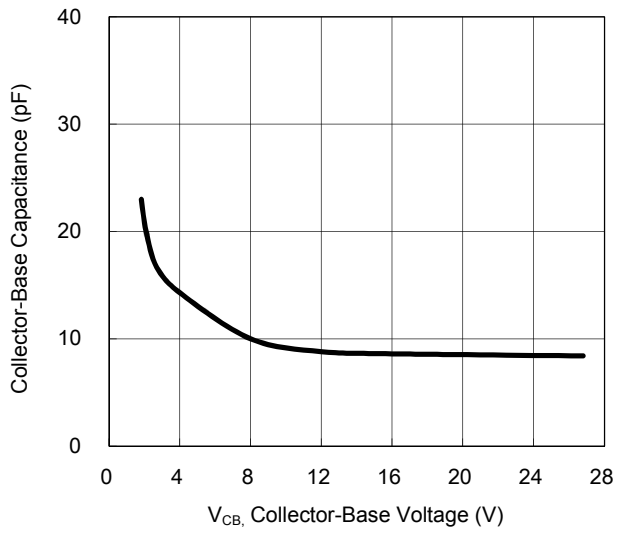

PACKAGE OUTLINE DIMENSION
SOT-23

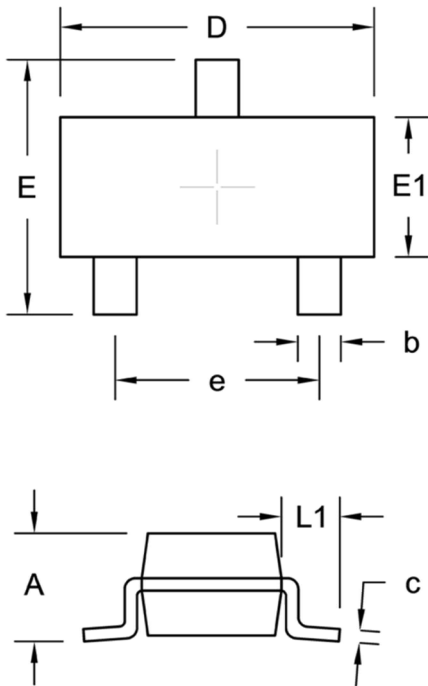

DIM.	Unit (mm)		Unit (inch)	
	Min.	Max.	Min.	Max.
A	0.89	1.12	0.035	0.044
b	0.30	0.50	0.012	0.020
c	0.08	0.20	0.003	0.008
D	2.80	3.04	0.110	0.120
E	2.10	2.64	0.083	0.104
E1	1.20	1.40	0.047	0.055
e	1.90 BSC		0.075 BSC	
L1	0.54 REF.		0.021 REF.	

SUGGESTED PAD LAYOUT

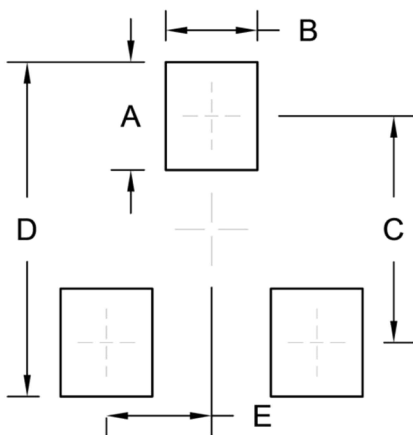

Symbol	Unit (mm)	Unit (inch)
A	1.00	0.039
B	0.85	0.033
C	2.10	0.083
D	3.10	0.122
E	0.98	0.039